

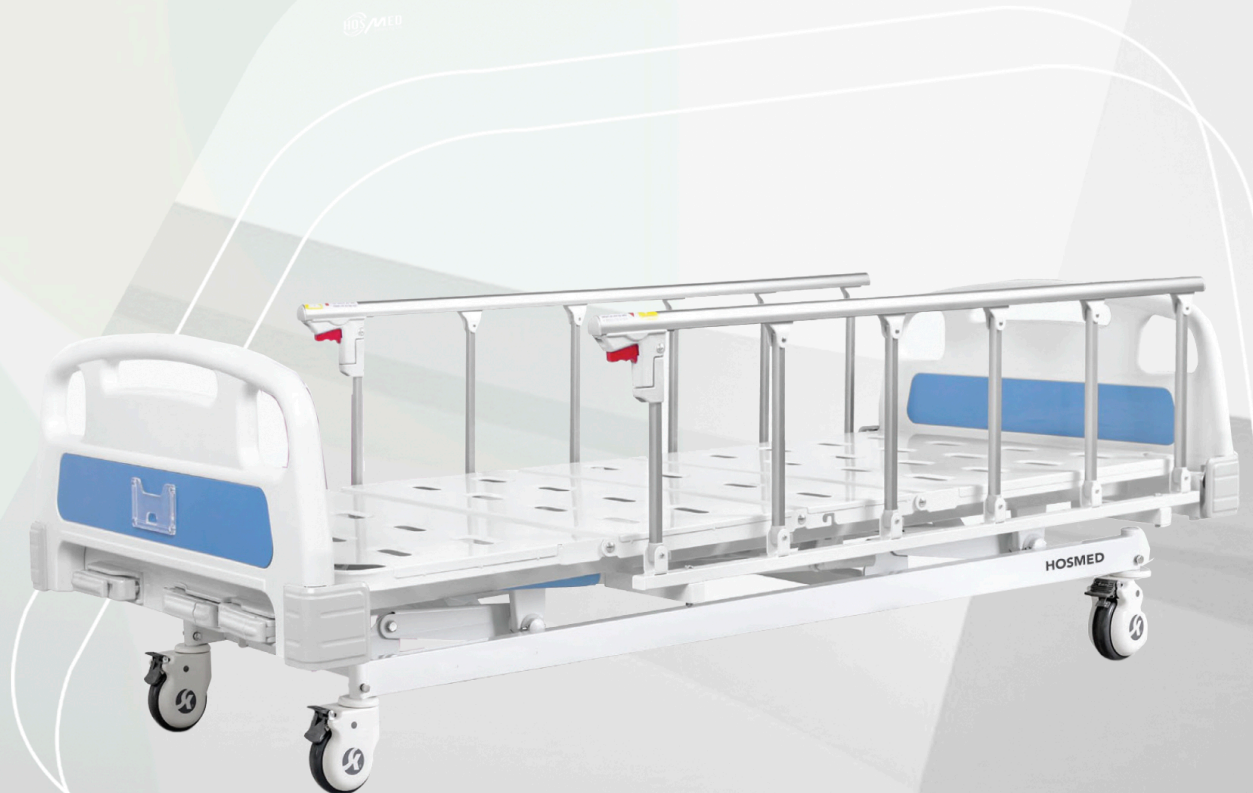

## 3 Position Manual Bed **NB3M**



# Features



## Steels | Painting

Baosteel from Fortune Global 500 11 Process epoxy painting, ASTM testing anti-bacterial, paint thickness 0.12 mm, brightness 60°, paint can resist 50kg impact



## Plastic

Environmental plastic can be sterilized in 100°C, tensile upto 30MPa Virgin ABS material



## Bumper Cover

Reduce the impact of the collision, safe and slinky.



## Hand Control

Retractable hand crank, 100,000 times remaining intact  
Extreme protection device, sounds when tipped to the max position, Strong pallets to increase the bed height adjustment(400-710mm)a



## Design

Morden design. Use new and strong inserted ABS fire-proof panel avoid off. Easy to be cleaned and installed. Net weight over 3.6kg.



## Platform

Stamping forming platform, smooth surface no welding scar, bearing 135KG load. Option resin X-ray translucent platform.

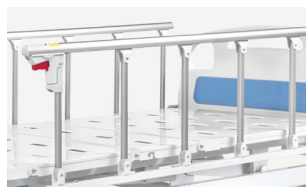

## Siderail

Aluminum alloy side rail, 6-staff, collapsed type with safe lock.



## Castors

5" covered casters TPR tire no worn out after running 30KM, save anti-winding hard shell, united forming without bolts. Pass Dynamic test: Bearing 120kg run 30KM and pass obstacles 500 time.

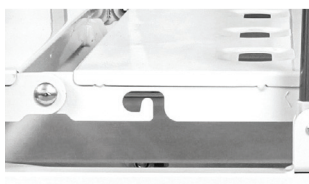

## Drainage Hooks

Laser cutting drainage hook, both sides.



## IV Pole

Full SS IV pole, bearing 15kg.

# Technical Chart

## Technical parameters

External size (LxWxH)	2110x960x400-710 mm
Mattress platform	1925x820 mm
Safe working load	135 kg
Back-rest adjustment	0-75° (±10°)
Knee-rest adjustment	0-35° (±10°)



## Technical configuration

Manual Cranks	3pcs
5" Covered Castors	4pcs
Foldable Side Rail	1set
ABS Bed ends with Safe lock	1set
IV Pole	1set
IV Pole Prevision	4pcs
Drainage Hook	4pcs
Mattress Holder	2pcs

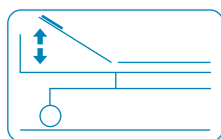
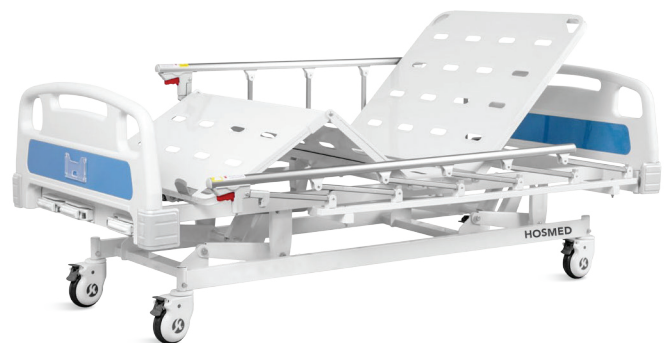

Back-rest  
adjustment

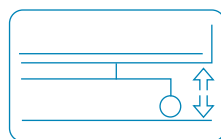

Height  
adjustment

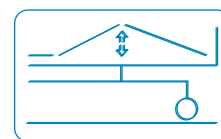

Knee-rest  
adjustment





3403 NW 82nd Avenue, Suite 102 E.  
Doral, Florida 33122. USA  
[www.hosmed-inc.com](http://www.hosmed-inc.com)